

# CONEXIONES PARA MANGUERA

Conexiones reusables, baja presión

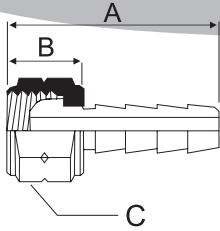

HEMBRA GIRATORIA NARIZ DE BOLA (PARA PISTOLA DE PINTURA)

Parte No.	Cuerda	Manguera		Dimensiones en plg.			Modelo
		DN	DI	A	B	C	
317	1/4 - 18 (-4)	6	1/4 (-4)	1" 7/16	1/2	5/8	H-4-4B

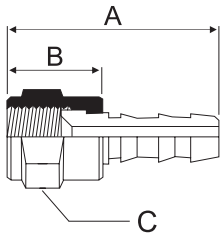

HEMBRA GIRATORIA ABOCINADO 45°

Parte No.	Cuerda UNF	Manguera		Dimensiones en plg.			Modelo
		DN	DI	A	B	C	
301	7/16 - 20 (-4)	6	1/4 (-4)	1" 7/16	5/8	9/16	H-4B
302	1/2 - 20 (-5)	6	1/4 (-4)	1" 7/16	11/32	5/8	H-5-4B
303	5/8 - 18 (-6)	10	3/8 (-6)	1" 23/32	13/32	3/4	H-6B
304	3/4 - 16 (-8)	12	1/2 (-8)	2"	13/16	7/8	H-8B
305	7/8 - 14 (-10)	16	5/8 (-10)	2" 1/8	15/16	1"	H-10B
306	1" 1/16 - 14 (-12)	19	3/4 (-12)	2" 5/8	1" 3/32	1" 1/4	H-12B

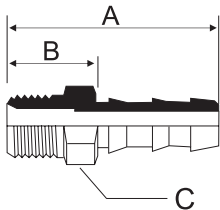

MACHO NPTF  
ESPIGA PARA MANGUERA

Parte No.	Cuerda NPTF	Manguera		Dimensiones en plg.			Modelo
		DN	DI	A	B	C	
311	1/8 - 27 (-2)	6	1/4 (-4)	1" 11/32	19/32	7/16	M-2-4B
312	1/4 - 18 (-4)	6	1/4 (-4)	1" 9/16	25/32	9/16	M-4-4B
313	1/4 - 18 (-4)	10	3/8 (-6)	1" 23/32	3/4	9/16	M-4-6B
314	3/8 - 18 (-6)	10	3/8 (-6)	1" 23/32	3/4	11/16	M-6-6B
315	1/2 - 14 (-8)	12	1/2 (-8)	2" 1/8	1"	7/8	M-8-8B
316	1/2 - 14 (-8)	16	5/8 (-10)	2" 1/8	1"	7/8	M-8-10B
321	3/4 - 14 (-12)	19	3/4 (-12)	2" 5/8	1" 1/18	1" 1/16	M-12-12B

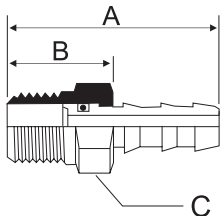

MACHO GIRATORIO NPTF  
ESPIGA PARA MANGUERA

Parte No.	Cuerda NPTF	Manguera		Dimensiones en plg.			Modelo
		DN	DI	A	B	C	
322	1/4 - 18 (-4)	6	1/4 (-4)	1" 1/2	3/4	9/16	M-4-4BG

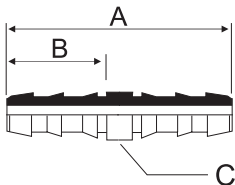

UNIDOR DE MANGUERA

Parte No.	Medida Espiga	Manguera		Dimensiones en plg.			Modelo
		DN	DI	A	B	C	
318	4 - 4 (1/4)	6	1/4 (-4)	1" 13/16	25/32	3/8	U-4-4
319	6 - 6 (3/8)	10	3/8 (-6)	2" 1/8	15/16	1/2	U-6-6
320	8 - 8 (1/2)	12	1/2 (-8)	2" 1/2	1" 1/8	11/16	U-8-8

# CONEXIONES PARA MANGUERA SAE 100R5

Conexiones reusables, mediana presión

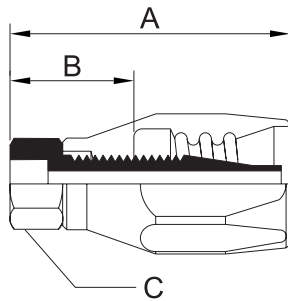

SALVAVIDAS

Parte No.	Diámetro Tubo	Manguera		Dimensiones en plg.			Modelo
		DN	DI	A	B	C	
421	1/4	6	3/16 (-4)	1" 3/8	19/32	3/8	SALV-4
422	5/16	10	5/16 (-6)	1" 21/32	3/4	1/2	SALV-5-6
423	3/8	10	5/16 (-6)	1" 21/32	3/4	1/2	SALV-6
424	1/2	12	13/32 (-8)	2" 1/16	15/16	5/8	SALV-8

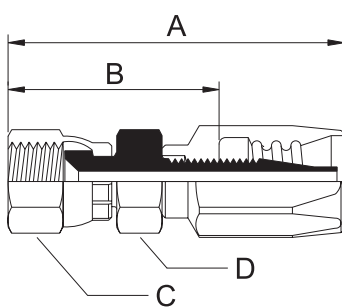

HEMERA GIRATORIA  
ABOCINADO 45°SAE

Parte No.	Cuerda UNF	Manguera		Dimensiones en plg.				Modelo
		DN	DI	A	B	C	D	
431	7/16 - 20	6	3/16 (-4)	2" 1/32	1" 5/16	9/16	9/16	H-4P
432	1/2 - 20	8	1/4 (-5)	2" 3/16	1" 3/8	5/8	9/16	H-5P
433	5/8 - 18	10	5/16 (-6)	2" 3/8	1" 1/2	3/4	3/4	H-6P
*434	9/16 - 18	10	5/16 (-6)	2" 3/8	1" 7/16	11/16	11/16	H-6P JIC
435	3/4 - 16	12	13/32 (-8)	2" 13/16	1" 5/8	7/8	7/8	H-8P
436	7/8 - 14	16	1/2 (-10)	3" 1/8	1" 13/16	1"	7/8	H-10P
437	1" 1/16 - 14	19	5/8 (-12)	3" 1/2	1" 7/8	1" 1/4	1" 1/4	H-12P
*480	1" 1/16 - 12	19	5/8 (-12)	3" 1/2	2"	1" 1/4	1" 1/4	H-12P JIC
*481	1" 5/16 - 12	25	7/8 (-16)	3" 1/4	2"	1" 1/2	1" 1/2	H-16P JIC
*482	1" 5/8 - 12	31	1" 1/8 (-20)	3" 9/16	2" 5/16	2"	2"	H-20P JIC
*483	1" 7/8 - 12	38	1" 3/8 (-24)	3" 15/16	1" 5/8	2" 1/4	2" 1/4	H-24P JIC

\*Abocinado 37°

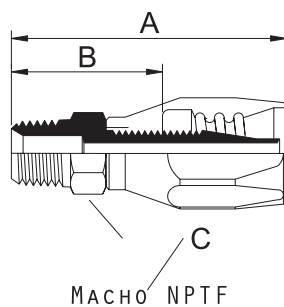

MACHO NPTF

Parte No.	Cuerda NPTF	Manguera		Dimensiones en plg.			Modelo
		DN	DI	A	B	C	
411	1/8 - 27 (-2)	6	3/16 (-4)	1" 11/16	15/16	7/16	M-2-4
412	1/4 - 18 (-4)	6	3/16 (-4)	1" 7/8	1" 1/8	9/16	M-4-4
413	1/4 - 18 (-4)	8	1/4 (-5)	1" 15/16	1" 3/16	9/16	M-4-5
414	1/4 - 18 (-4)	10	5/16 (-6)	2" 1/8	1" 3/16	9/16	M-4-6
410	3/8 - 18 (-6)	10	5/16 (-6)	2" 1/8	1" 3/16	11/16	M-6-6
426	3/8 - 18 (-6)	12	13/32 (-8)	2" 7/16	1" 5/16	11/16	M-6-8
415	1/2 - 14 (-8)	12	13/32 (-8)	2" 5/8	1" 1/2	7/8	M-8-8
416	1/2 - 14 (-8)	16	1/2 (-10)	2" 27/32	1" 1/2	7/8	M-8-10
428	3/4 - 14 (-12)	19	5/8 (-12)	3" 1/4	1" 5/8	1" 1/16	M-12-12
484	1" -11 1/2 (-16)	25	7/8 (-16)	3"	1" 13/16	1" 3/8	M-16-16
485	1" 1/4 -11 1/2 (-16)	31	1" 1/8 (-20)	3" 1/4	2"	1" 3/4	M-20-20
486	1" 1/2 -11 1/2 (-16)	38	1" 3/8 (-24)	3" 1/2	2" 1/8	2"	M-24-24

# CONEXIONES PARA FRENOS DE AIRE



Conexiones reusables

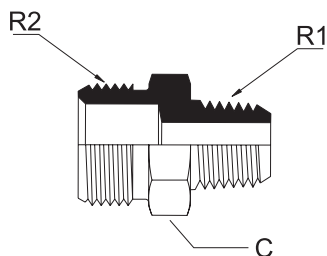

ADAPTADOR

Parte No.	R1 NPTF	R2 UNF	C Hex.	Modelo
601	1/4 - 18 (-4)	3/4 - 20 (-8)	3/4	AMF-4-8
600	3/8 - 18 (-6)	3/4 - 20 (-8)	3/4	AMF-6-8

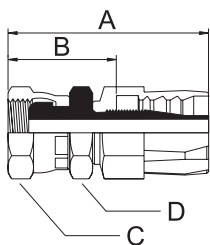

HEMBRA GIRATORIA  
NARIZ DE BOLA

Parte No.	Cuerda UNF	Manguera		Dimensiones en plg.				Modelo
		DN	DI	A	B	C	D	
602	3/4 - 20 (-8)	10	3/8 (-6)	2" 3/16	1 1/4	7/8	7/8	CHF-8-6

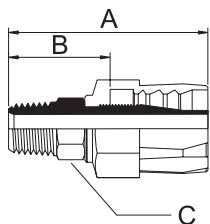

MACHO NPTF

Parte No.	Cuerda NPTF	Manguera		Dimensiones en plg.			Modelo
		DN	DI	A	B	C	
603	1/4 - 18 (-4)	10	3/8 (-6)	2" 1/16	1" 1/16	9/16	CMF-4
626	3/8 - 18 (-6)	10	3/8 (-6)	2" 1/16	1" 1/16	9/16	CMF-6

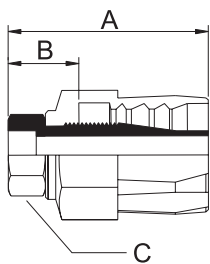

SALVAVIDAS

Parte No.	Tubo DE	Manguera		Dimensiones en plg.			Modelo
		DN	DI	A	B	C	
604	5/16	6	3/8 (-6)	1" 9/16	9/16	9/16	SALV-5-6F
605	3/8	10	3/8 (-6)	1" 9/16	9/16	9/16	SALV-6-6F

# CONEXIONES PARA MANGUERA DE GASOLINA

Conexiones reusables y permanentes. ANTICHISPA

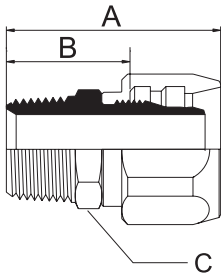

MACHO NPTF

REUSABLE 2 PIEZAS, CASQUILLO DE ALUMINIO

Parte No.	Cuerda NPTF	Manguera		Dimensiones en plg.			Modelo
		DN	DI	A	B	C	
613	3/4 - 14 (-12)	16	5/8 (-10)	2" 1/2	1" 1/2	1" 1/16	CPMG-5/8
611	3/4 - 14 (-12)	19	3/4 (-12)	2" 1/2	1" 1/2	1" 1/16	CPMG-3/4
612	1" 11 1/2 (-16)	25	1" (-16)	2" 15/16	1" 9/16	1" 3/8	CPMG-1"

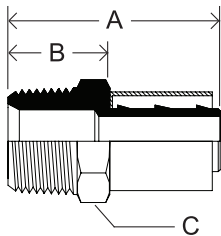

MACHO NPTF

FÉRULA DE ALUMINIO

Parte No.	Cuerda NPTF	Manguera		Dimensiones en plg.			Modelo
		DN	DI	A	B	C	
623	3/4 - 14 (-12)	16	5/8 (-10)	2" 3/32	1"	1" 1/16	MPG-12-10
624	3/4 - 14 (-12)	19	3/4 (-12)	2" 1/4	1" 1/18	1" 1/16	MPG-12-12
625	1" - 11 1/2 (-16)	25	1" (-16)	2" 7/8	1" 5/16	1" 3/8	MPG-16-16

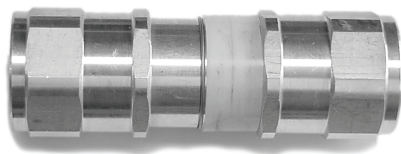

VÁLVULA DE SEGURIDAD

Parte No.	Cuerda hembra NPTF	Material	Fuerza de tensión	Modelo
621	3/4 - 14 (-12)	Aluminio	113 kg. (250 lb.)	VCRG-3/4
622	1" - 11 1/2 (-16)	Aluminio	136 kg. (300 lb.)	VCRGD-1"

Si la válvula se acciona, los sellos se activan automáticamente sellando ambos extremos de la manguera.

# CONEXIONES PARA HIDROLAVADORAS



Conexiones permanentes para manguera de Hidrolavadoras.

Para manguera SAE 100 R1, SAE 100 R2, SAE 100 R17

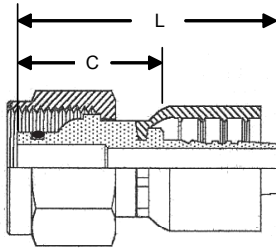

HEMBRA MÉTRICA GIRATORIA  
CON "O" RING

Modelo	Rosca mm.	Manguera D.N.	D.I.	L plg.	C plg.
CAP3CK-22-4	M22X1.5	6	1/4 (-4)	2 5/32	1 1/16
CAP3CK-22-6	M22X1.5	10	3/8 (-6)	2 9/32	1 5/64

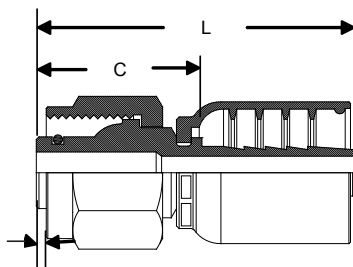

1.6 mm.

HEMBRA MÉTRICA GIRATORIA  
CON "O" RING

Modelo	Rosca mm.	Manguera D.N.	D.I.	L plg.	C plg.
CAP3CK-22-4L	M22X1.5	6	1/4 (-4)	2 9/32	1 1/16
CAP3CK-22-6L	M22X1.5	10	3/8 (-6)	2 3/8	1 5/64

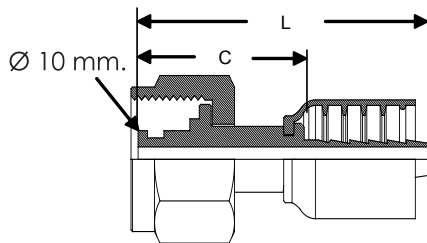

HEMBRA MÉTRICA

Modelo	Rosca mm.	Manguera D.N.	D.I.	L plg.	C plg.
CAP3CK22-10-4	M22X1.5	6	1/4 (-4)	2 7/16	1 1/16

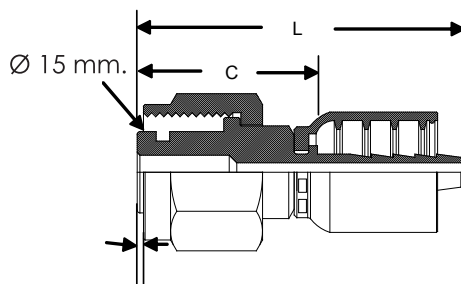

1.1 mm.

HEMBRA MÉTRICA

Modelo	Rosca mm.	Manguera D.N.	D.I.	L plg.	C plg.
CAP3CKP15-4C	M22X1.5	6	1/4 (-4)	1 5/8	1 1/16

# CONEXIONES PARA HIDROLAVADORAS

Conexiones permanentes para manguera de Hidrolavadoras.

Para manguera SAE 100 R1, SAE 100 R2, SAE 100 R17

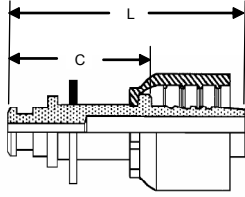

CONEXIÓN PARA PISTOLA  
RONDANA GIRATORIA

Modelo	Manguera		L	C
	D.N.	D.I.	plg.	plg.
CAP3CKP-4	6	1/4 (-4)	2 7/16	1 1/16
CAP3CKP-6	10	3/8 (-6)	2	1 5/64

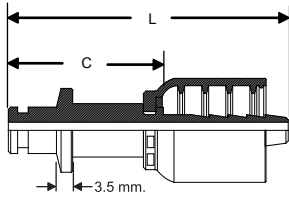

CONEXIÓN PARA PISTOLA  
RONDANA ABOCINADA

Modelo	Manguera		L	C
	D.N.	D.I.	plg.	plg.
CAP3CKP18-4	6	1/4 (-4)	2 3/8	1 1/16

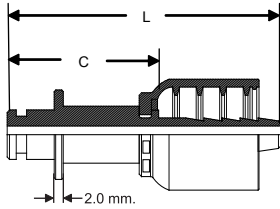

CONEXIÓN PARA PISTOLA  
RONDANA FIJA

Modelo	Manguera		L	C
	D.N.	D.I.	plg.	plg.
CAP3CKP18-4P	6	1/4 (-4)	2 3/8	1 1/16

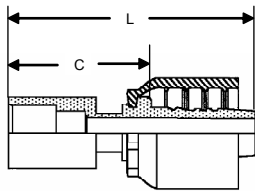

CONEXIÓN PARA BOMBA

Modelo	Manguera		L	C
	D.N.	D.I.	plg.	plg.
CAP3CKB-4	6	1/4 (-4)	23/8	1 1/16
CAP3CKB-6	10	3/8 (-6)	2 7/16	1 5/64

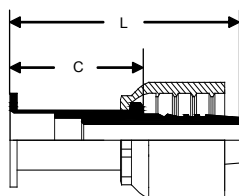

CONEXIÓN PARA PISTOLA  
CON CHECK

Modelo	Manguera		L	C
	D.I.		plg.	plg.
CAP3CKPV-4	1/4 (-4)		2 5/16	1 1/16